

ivv

SRc[®]









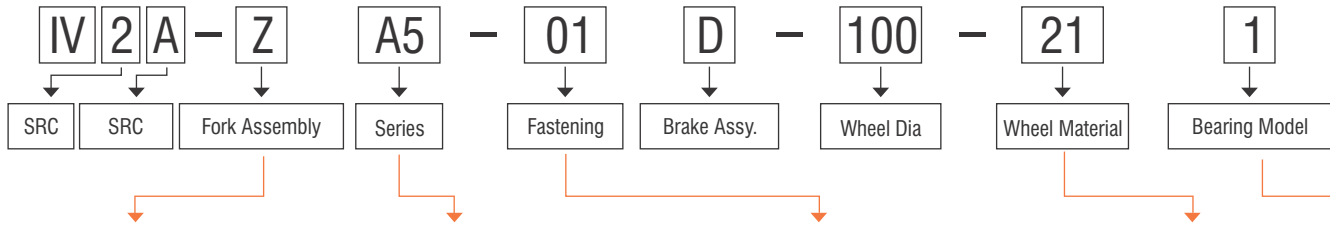



+

+

Part Numbering System



Fork Assembly	Series No.	Fastening	Wheel Material
 Z = (Zinc Plated)	A1	04 - Fix	12 = Polyolefin (round tread)
	A2		16 = Hi-tech Polyurethane (round tread)
 B = (Black color painted)	A3		01 - Swivel
	A5	21 = Polyurethane (round tread)	
		 01D - Swivel + Brake	Bearing Model  1 = Central precision ball bearing
		 02 - Thread Stem	 2 = Double ball bearing
		 02D - Thread + Brake	 3 = Derlin bearing
		 E - Single brake (Plastic)	 4 = Plain bore (bushing)

Wheel and material introduction



Plain bore bearing PP wheel
Size : 25/38/50/63/75 mm

Wheel Structure



IV-2A-ZA1-04-50-124



IV-2A-ZA1-01-63-124



IV-2A-ZA1-01E-75-124



IV-2A-ZA1-02-63-124



IV-2A-ZA1-02E-75-124

Wheel dia (mm)	Tread width (mm)	Load capacity (kg.) Per Pc.	Wheel material	Loading hight (mm)	Swivel radius (mm)	Brake swivel radius (mm)	Plate size (mm)	Plate size (mm)		
25 MM (1")	13	7	POLY PROPYLENE (PP)	35	25	46	(A) 30X24 (B) 38X33 (D) 4.3	(A) 29X13 (B) 36X20	PLAIN BORE	IV-2A-ZA1-04-25-124
										IV-2A-ZA1-01-25-124
										IV-2A-ZA1-01E-25-124
38 MM (1.5")	18	16	POLY PROPYLENE (PP)	50.5	36	56	(A) 36X20 (B) 46X38 (D) 5.3	(A) 36X15 (B) 46X25	PLAIN BORE	IV-2A-ZA1-04-38-124
										IV-2A-ZA1-01-38-124
										IV-2A-ZA1-01E-38-124
50 MM (2")	22	25	POLY PROPYLENE (PP)	65	48	71	(A) 46X35 (B) 59X47 (D) 6.5	(A) 45X25 (B) 58X40	PLAIN BORE	IV-2A-ZA1-04-50-124
										IV-2A-ZA1-01-50-124
										IV-2A-ZA1-01E-50-124
								Thread M8X20		IV-2A-ZA1-02-50-124
										IV-2A-ZA1-02E-50-124
63 MM (2.5")	28	35	POLY PROPYLENE (PP)	82	60	86	(A) 55X42 (B) 70X58 (D) 8.5	(A) 55X28 (B) 70X47	PLAIN BORE	IV-2A-ZA1-04-63-124
										IV-2A-ZA1-01-63-124
										IV-2A-ZA1-01E-63-124
								Thread M12X25		IV-2A-ZA1-02-63-124
										IV-2A-ZA1-02E-63-124
75 MM (3")	28	45	POLY PROPYLENE (PP)	93	66	90	(A) 55X42 (B) 70X58 (D) 8.5	(A) 55X28 (B) 70X47	PLAIN BORE	IV-2A-ZA1-04-75-124
										IV-2A-ZA1-01-75-124
										IV-2A-ZA1-01E-75-124
								Thread M12x25		IV-2A-ZA1-02-75-124
										IV-2A-ZA1-02E-75-124



IV-2A-ZA2-04-75-121



IV-2A-ZA2-01-100-121



IV-2A-ZA2-01D-125-121



IV-2A-ZA2-02-75-121



IV-2A-ZA2-02D-100-121

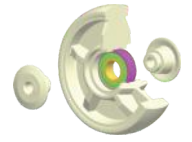

Wheel Structure

Single ball bearing
PP wheel
Size : 75/100/125mm

Wheel dia (mm)	Tread width (mm)	Load capacity (kg.) Per Pc.	Wheel material	Loading height (mm)	Swivel radius (mm)	Brake swivel radius (mm)	Plate size (mm)	Thread size (mm)	Bearing	Product Code
75 MM (3")	28	70	POLY PROPYLENE (PP)	104	69	93	(A)75 x 44 (B)91 x 63 (C)71 x 44 (D) 9	M 12 x 25	Single Ball Bearing	IV-2A-ZA2-04-75-121
				102						IV-2A-ZA2-01-75-121
100 MM (4")	28	80	POLY PROPYLENE (PP)	129	85	100	(A)75 x 44 (B)91 x 63 (C)71 x 44 (D)9	M 12 x 25	Single Ball Bearing	IV-2A-ZA2-04-100-121
				127						IV-2A-ZA2-01-100-121
125 MM (5")	28	90	POLY PROPYLENE (PP)	155	104	110	(A)75 x 44 (B)91 x 63 (C)71 x 44 (D)9	M 12 x 25	Single Ball Bearing	IV-2A-ZA2-04-125-121
				153						IV-2A-ZA2-01-125-121
										IV-2A-ZA2-01D-125-121
										IV-2A-ZA2-02-125-121
										IV-2A-ZA2-02D-125-121



IV-2A-BA1-04-50-214



IV-2A-BA1-01-63-214



IV-2A-BA1-01E-75-214



IV-2A-BA1-02-50-214







IV-2A-BA1-02E-75-214



Wheel Structure

Plain bore bearing
PU wheel
Size : 50/63/75mm

Wheel dia (mm)	Tread width (mm)	Load capacity (kg.) Per Pc.	Wheel material	Loading height (mm)	Swivel radius (mm)	Brake swivel radius (mm)	Plate size (mm)	Plate size (mm)	Bearing	Product Code
50 MM (2")	22	22	Poly Urethane (PU)	65	46	71	(A) 46X35 (B) 59X47 (D) 6.5	(A) 45X25 (B) 58X40	PLAIN BORE	IV-2A-BA1-04-50-214
								Thread M8X20		IV-2A-BA1-01-50-214
63 MM (2.5")	28	30	Poly Urethane (PU)	82	57	83	(A) 55X42 (B) 70X58 (D) 8.5	(A) 55X28 (B) 70X47	PLAIN BORE	IV-2A-BA1-04-63-214
								Thread M12X25		IV-2A-BA1-01-63-214
75 MM (3")	28	40	Poly Urethane (PU)	93	63	87	(A) 55X42 (B) 70X58 (D) 8.5	(A) 55X28 (B) 70X47	PLAIN BORE	IV2A-BA1-04-75-214
								Thread M12x25		IV2A-BA1-01-75-214
										IV2A-BA1-01E-75-214
										IV2A-BA1-02-75-214
										IV2A-BA1-02E-75-214

PRODUCT	Wheel dia (mm)	Tread width (mm)	Load capacity (kg)	Wheel material	Loading height (mm)	Swivel radius (mm)			NO. Model
 IV-2A-BA3-04-75-211	63 (2.5")	32	65	Polyurethane (PU)	93.5	67.5	(A) 78x45 (B) 95x66 (C) 71x45 (D) 8.6		IV-2A-BA3-04-63-211
					91				IV-2A-BA3-01-63-211
 IV-2A-BA3-01-100-211	75 (3")	32	90	Polyurethane (PU)	105.5	74	(A) 78x45 (B) 95x66 (C) 71x45 (D) 8.6	Single Ball Bearing	IV-2A-BA3-01D-63-211
					103				IV-2A-BA3-02-63-211
 IV-2A-BA3-01D-125-211	100 (4")	32	120	Polyurethane (PU)	130	86	(A) 78x45 (B) 95x66 (C) 71x45 (D) 8.6	Thread Stem M12x25	IV-2A-BA3-02D-63-211
					127.5				IV-2A-A3-63x32-211-WH
 IV-2A-BA3-02-100-211	125 (5")	32	130	Polyurethane (PU)	154.5	99	(A) 78x45 (B) 95x66 (C) 71x45 (D) 8.6		IV-2A-BA3-04-75-211
					152				IV-2A-BA3-01-75-211
									IV-2A-BA3-01D-75-211
									IV-2A-BA3-02-75-211
									IV-2A-BA3-02D-75-211
									IV-2A-A3-75x32-211-WH
									IV-2A-BA3-04-100-211
									IV-2A-BA3-01-100-211
									IV-2A-BA3-01D-100-211
									IV-2A-BA3-02-100-211
									IV-2A-BA3-02D-100-211
									IV-2A-A3-100x32-211-WH
									IV-2A-BA3-04-125-211
									IV-2A-BA3-01-125-211
									IV-2A-BA3-01D-125-211
									IV-2A-BA3-02-125-211
									IV-2A-BA3-02D-125-211
									IV-2A-A3-125x32-211-WH

Polyurethane Wheel with C.I. Core Double Ball Bearing

PRODUCT	Wheel dia (mm)	Tread width (mm)	Load capacity (kg)	Wheel material	Loading height (mm)	Swivel radius (mm)			NO. Model
 IV-2A-ZA5-04-100-272	100 (4")	50	280	Polyurethane (PU) C.I. Core	143	87	(A) 92x67 (B) 115x100 (C) 76x76 (D) 11	Double Ball Bearing	IV-2A-ZA5-04-100-272
									IV-2A-ZA5-01-100-272
									IV-2A-ZA5-01D-100-272
									IV-2A-A5-100X50-272-WH
 IV-2A-ZA5-04-125-272	125 (5")	50	380	Polyurethane (PU) C.I. Core	164	105	(A) 92x67 (B) 115x100 (C) 76x76 (D) 11	Double Ball Bearing	IV-2A-ZA5-04-125-272
									IV-2A-ZA5-01-125-272
									IV-2A-ZA5-01D-125-272
									IV-2A-A5-125X50-272-WH
 IV-2A-ZA5-01-150-272	150 (6")	50	430	Polyurethane (PU) C.I. Core	190	121	(A) 92x67 (B) 115x100 (C) 76x76 (D) 11	Double Ball Bearing	IV-2A-ZA5-04-150-272
									IV-2A-ZA5-01-150-272
									IV-2A-ZA5-01D-150-272
									IV-2A-A5-150X50-272-WH
 IV-2A-ZA5-01D-200-272	200 (8")	50	500	Polyurethane (PU) C.I. Core	240	160	(A) 92x67 (B) 115x100 (C) 76x76 (D) 11	Double Ball Bearing	IV-2A-ZA5-04-200-272
									IV-2A-ZA5-01-200-272
									IV-2A-ZA5-01D-200-272
									IV-2A-A5-200X50-272-WH

PRODUCT	Wheel dia (mm)	Tread width (mm)	Wheel material	Load capacity (kg)	Loading height (mm)	Swivel radius (mm)			NO. Model
 IV-2A-ZA5-04-100-212	100 (4")	45	Poly Urethane (PU)	200	143	87	(A) 92x67 (B) 115x100 (C) 76x76 (D) 11	 Double Ball Bearing	IV-2A-ZA5-04-100-212
									IV-2A-ZA5-01-100-212
									IV-2A-ZA5-01D-100-212
									IV-2A-A5-100X45-212-WH
 IV-2A-ZA5-04-125-212	125 (5")	45	Poly Urethane (PU)	270	164	105	(A) 92x67 (B) 115x100 (C) 76x76 (D) 11	 Double Ball Bearing	IV-2A-ZA5-04-125-212
									IV-2A-ZA5-01-125-212
									IV-2A-ZA5-01D-125-212
									IV-2A-A5-125X45-212-WH
 IV-2A-ZA5-01-150-212	150 (6")	45	Poly Urethane (PU)	330	190	121	(A) 92x67 (B) 115x100 (C) 76x76 (D) 11	 Double Ball Bearing	IV-2A-ZA5-04-150-212
									IV-2A-ZA5-01-150-212
									IV-2A-ZA5-01D-150-212
									IV-2A-A5-150X45-212-WH
 IV-2A-ZA5-01D-200-212	200 (8")	45	Poly Urethane (PU)	360	240	160	(A) 92x67 (B) 115x100 (C) 76x76 (D) 11	 Double Ball Bearing	IV-2A-ZA5-04-200-212
									IV-2A-ZA5-01-200-212
									IV-2A-ZA5-01D-200-212
									IV-2A-A5-200X45-212-WH
 IV-2A-ZA5-04-125-212	100 (4")	45	Poly proplene (PP)	280	143	87	(A) 92x67 (B) 115x100 (C) 76x76 (D) 11	 Double Ball Bearing	IV-2A-ZA5-04-100-212
									IV-2A-ZA5-01-100-212
									IV-2A-ZA5-01D-100-212
									IV-2A-A5-100X45-212-WH
 IV-2A-ZA5-01-150-212	125 (5")	45	Poly proplene (PP)	340	164	105	(A) 92x67 (B) 115x100 (C) 76x76 (D) 11	 Double Ball Bearing	IV-2A-ZA5-04-125-212
									IV-2A-ZA5-01-125-212
									IV-2A-ZA5-01D-125-212
									IV-2A-A5-125X45-212-WH
 IV-2A-ZA5-01D-200-212	150 (6")	45	Poly proplene (PP)	400	190	121	(A) 92x67 (B) 115x100 (C) 76x76 (D) 11	 Double Ball Bearing	IV-2A-ZA5-04-150-212
									IV-2A-ZA5-01-150-212
									IV-2A-ZA5-01D-150-212
									IV-2A-A5-150X45-212-WH
	200 (8")	45	Poly proplene (PP)	440	240	160	(A) 92x67 (B) 115x100 (C) 76x76 (D) 11	 Double Ball Bearing	IV-2A-ZA5-04-200-212
									IV-2A-ZA5-01-200-212
									IV-2A-ZA5-01D-200-212
									IV-2A-A5-200X45-212-WH

PLATE DIMENSIONS : FIX CASTER

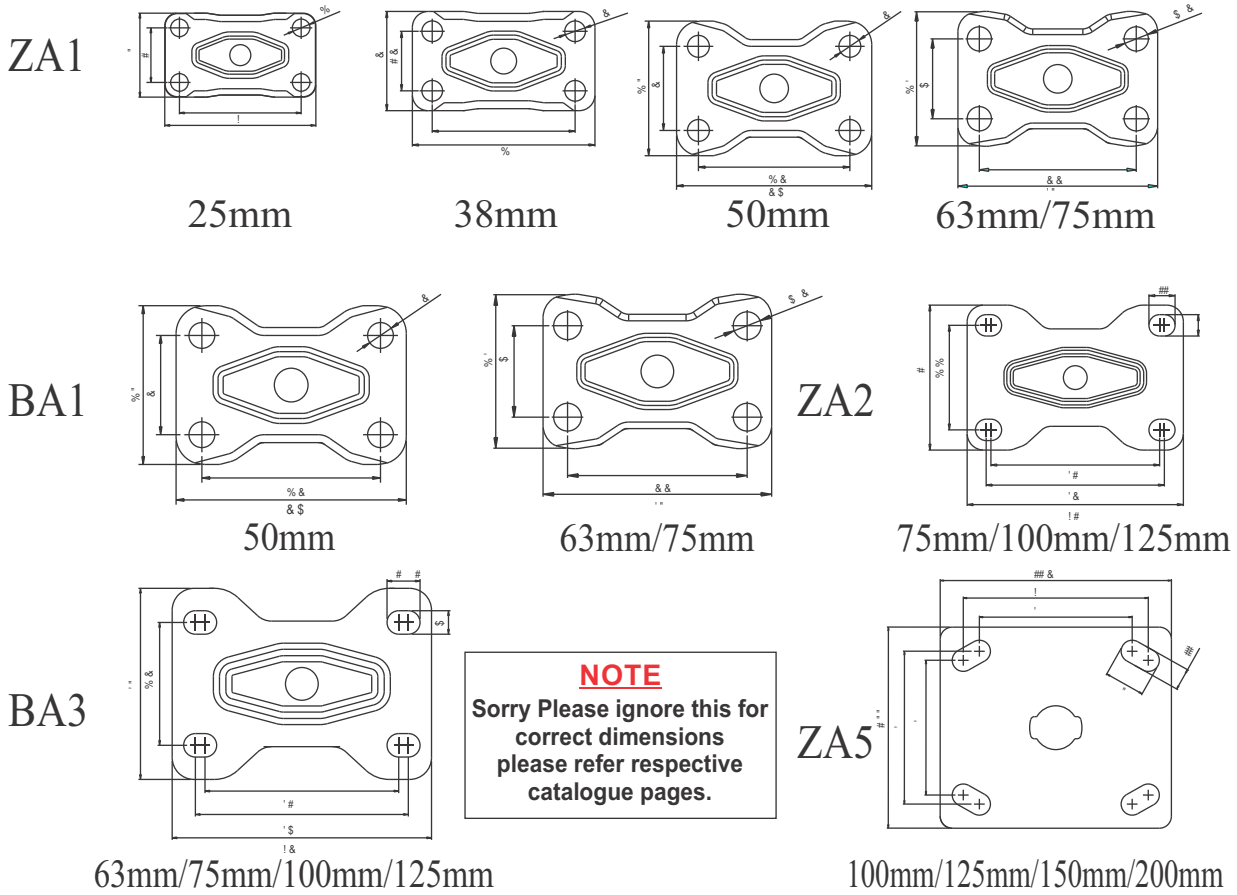
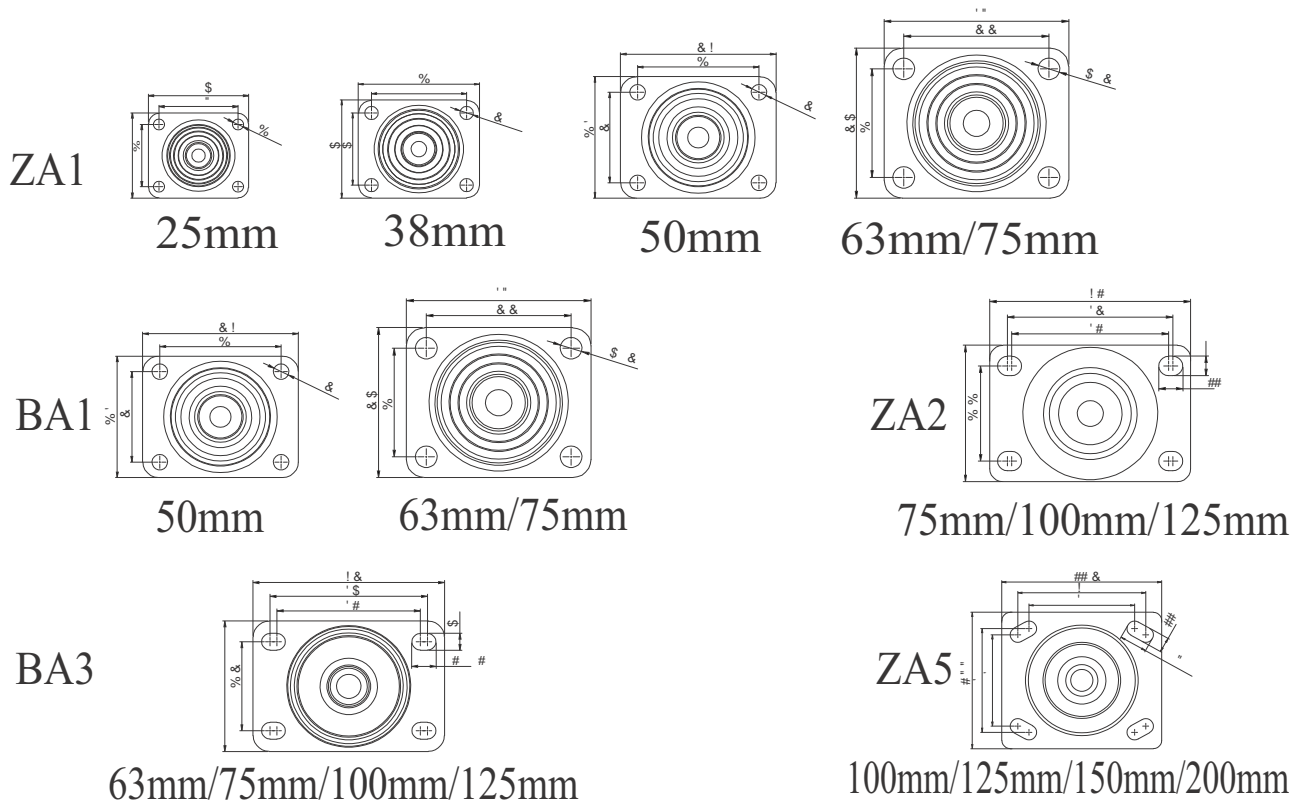
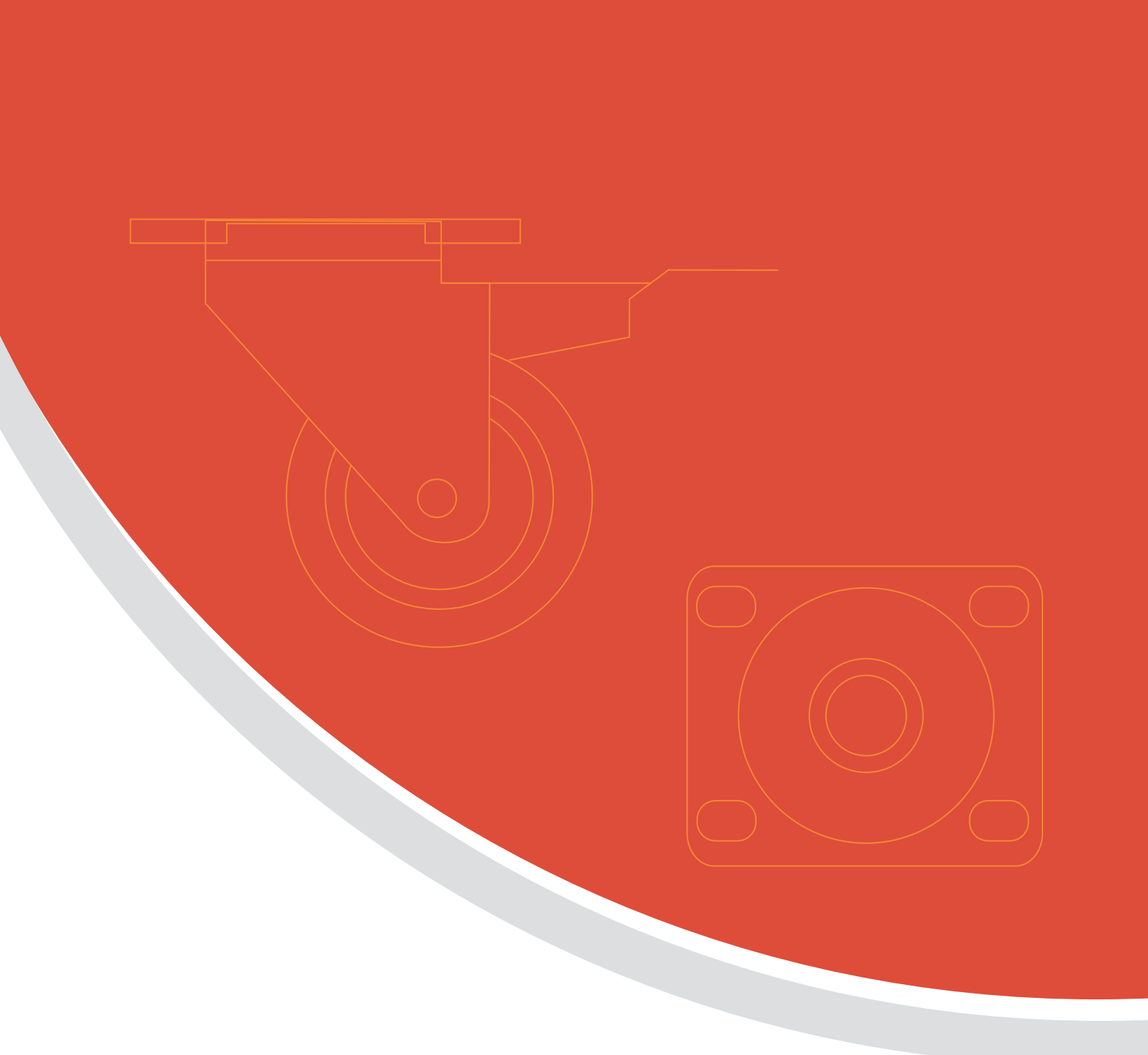

PLATE DIMENSIONS : SWIVEL PLATE CASTER





NOTE

**Sorry, please ignore this
for correct dimensions
refer respective
catalogue pages.**